







**SAFETY RULES**

-  Connect only in accordance with the diagram presented in the manual. Improper connections may be dangerous, it can damage the controller, and loss of the warranty.
-  **DANGER!** Risk of electric shock! Even with the device turned off, the outputs may be live. All assembly work should be ALWAYS performed with the disconnected power circuit.
-  Connecting the device to a power supply that does not meet the quality requirements specified in EN 50081-1, EN 50082-1, UL508, EN 60950 will invalidate the warranty.
-  Apply the safety systems described in the PN-EN 13241 standard defining the safety requirements and operational requirements for gates and barriers.

**1**

**INSTALLATION - BASICS**

- Disconnect the installation supply voltage before installing the controller. Remember that any mounting works should be carried out when the mains voltage is disconnected (switch off the mains fuse or disconnect the power cord from the mains socket).
- The controller should be installed in a place protected against accidental destruction, eg. screwed to the fence pole or inside the enclosure of the controlled device. Remember that metallic elements (wires, housing parts) have a negative influence on the range of the device, and consequently the comfort of use. It is recommended that the device be mounted in a stable and fixed position with the antenna upside. When installing the device outside of dry rooms, pay special attention to provide tightness of the rubber cable glands.

**GENERAL CONNECTION DIAGRAM:**

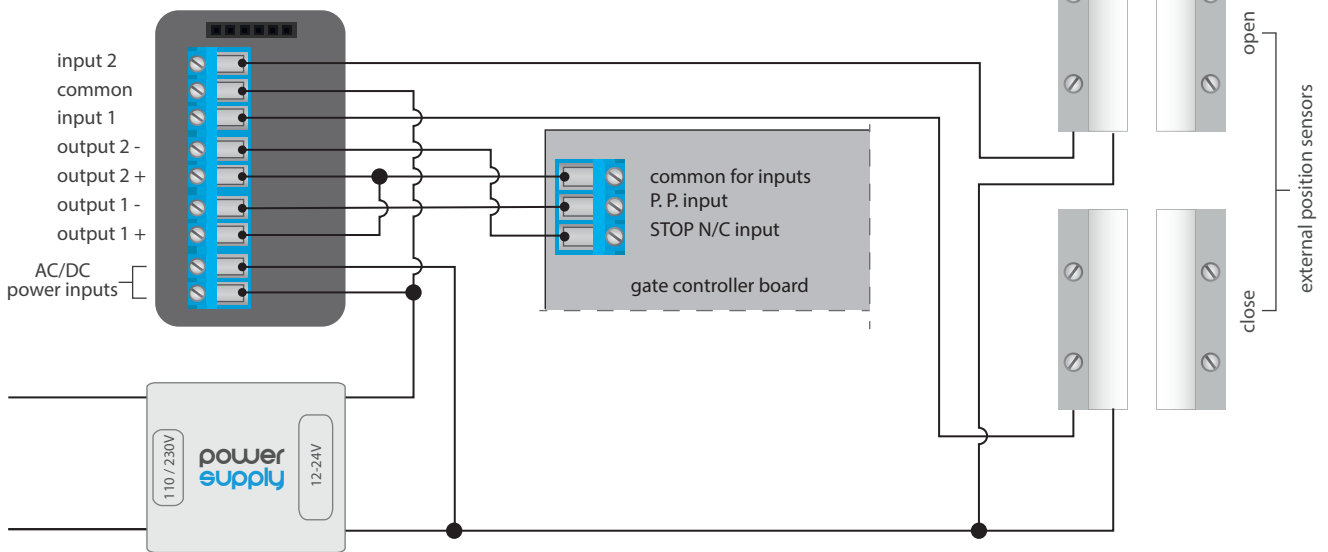

**CONNECTION DIAGRAM TO TYPICAL CONTROL PANEL:**

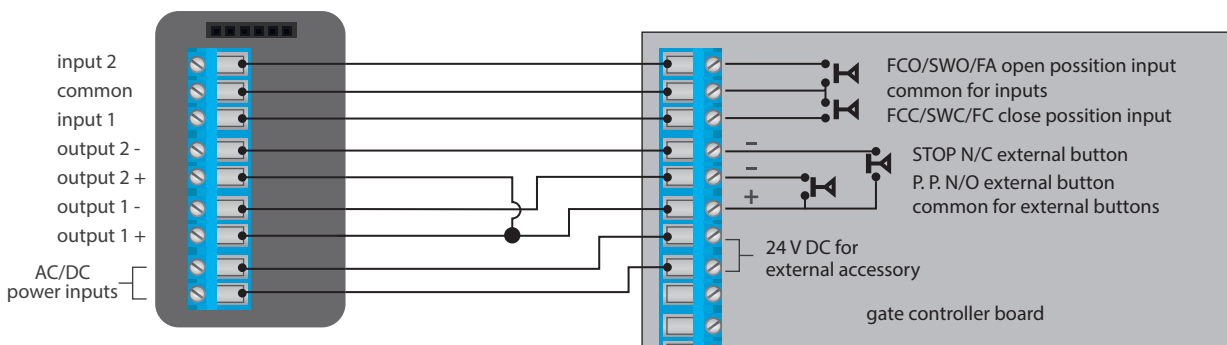

- Read the diagram and then proceed to install the controller. Pay particular attention to the designation of the controller connectors. Start by connecting the + 12V / + 24V power wires (red or black with a white dotted line) and GND (black).
- Paying attention to the polarity, connect the inputs controlling the engine control panel. Depending on the control panel, will be necessary to connect one or two inputs. The controller output O1 is destined for control in the open / stop / close mode. The O2 output is an auxiliary output, applicable in the control panel requiring a connection stop circuit when the motor works, or may be used as an additional function, e.g. "wicket" if the control panel is equipped with this functionality.



**Pay attention to the maximum output current capacity - the control current cannot exceed 20mA per output. Overloading the output will cause irreparable damage to the controller.**



**Information advanced for installers in relation to the output polarity, when is connected to engines control panels for which the scheme is not available.**

It is necessary to connect the right pin of the given output (O1 / O2) so that it has a higher potential than the left pin. In case of an inverted connection, due to the internal construction, it will connect the output which may cause the movement of the motor even without control it. In this situation, it is necessary to reverse the pair of wires connected inside output.

- If the motor has electromechanical limits switch, it is possible to receive feedback from the controller, indicating the position of the motor in the positions "Open" (intermediate position) "Closed". To do this, connect input IN1 of the controller to the connector of the motor control panel which indicates the closed position of the motor (usually FTC, SWC, FC), the IN2 input should be connected to the connector indicating the open position of the motor (usually FCO, SWO, FA), while the common COM input of the controller should be connected to the corresponding common signaling of the motor control panel. The connection polarity of the controller inputs is not significant.



The meaning states of the limits detected in the IN1 / IN2 inputs (it mean which of the IN1 or IN2 inputs indicates the closed position and which the open position) can be changed in the controller settings menu in the option "Replace inputs".



**Information advanced for installers regarding inputs, when is connected to a motor control panel for which is not available diagram.**

The limit state is detected if there is a current flowing between the IN1 and COM connectors and between the IN2 and COM does not. Analogously, the opposite state will be detected when there is no current flowing between the IN1 and COM connectors, and will flow between the IN2 and COM connectors. Any other configuration of the current flow is equivalent to the motor position beyond the limit positions. Inputs IN1, IN2 and COM have no specific polarity, they are galvanically isolated from the rest of the controller. The range of allowable voltages on the individual input pairs is 12 - 24V AC / DC.

- After making sure that the device is connected in accordance with the diagram and that there are no metal components near the controller which may accidentally cause short-circuit, start the device by turning on the power (turning on the mains fuse or connecting the power cord to the power outlet).

## 2

## FIRST START

- Download the **free wBox application**. If you have an Android mobile device, you will find the application in the Play Store. For iOS devices the application is in the App Store.
- By using your mobile phone or tablet, connect it to the device wireless network. To do this, enter to your smartphone or tablet settings, then go to setting of the WiFi network and find the network name "gateBoxPro-xxxxxxxx" where xxxxxxxx is the serial number of the device. Connect to this network.
- Open the wBox application. A device will appear at the top of the screen. To add it to the application, click on "+" on the right side of the name. To pre-configure the controller, click on the default device name.



You can also set the configuration using the web browser of your phone / tablet. After connecting to the wireless network of the controller, turn on the browser and go website [www.blebox.eu](http://www.blebox.eu)

- Go to "Settings" (icon in the upper right corner of the screen), go to the "Gate settings" section and select the appropriate option in the "Gate type" field. Then, depending on your control panel, select the function of the second (auxiliary) output. After saving the settings, go to the main panel by clicking the arrow in the upper left corner. Test the controller work of by clicking the gate / door icon - the control panel should force the motor to move.
- In the "Gate settings" section, in the field "Address (URL) of the MJPEG stream" you can enter the URL stream of the camera IP which supervise the motor.

### **In case you need to make changes in the advanced controller settings, click on "Show advanced" button. Will appear additional options.**

- In the "Gate output type" field, the output behavior can be changed between the normally open output (NO - when the output is not shorten) or normally closed (NC - in other words the contact pair is shorten, opens when the user presses the control button). It is also possible to adjust the duration of the impulse in the output - between 0.1 sec. to 15 seconds - after a single press of the control button. The option "Outputs swap" allows you to correct the order of pairs of wires without switching them again, for example when the gate control wire has been connected to the O2 output instead of under O1.
- Go to the main panel by clicking the arrow in the upper left corner. If the motor position sensor circuit has been connected, test the gate work - click on the gate / door icon, the control panel should force the motor to move. Note the blue border around the icon. If the motor is in an intermediate position, the icon's border will be half blue and half gray. The limit position in the "Open" state is indicated by a gray border and in the "Closed" state by a blue border.
- If you need to change the advanced settings of the controller associated with the inputs, return to the controller settings, go to the "Gate settings" section and then click the "Show advanced" button. Will appear additional options. If despite the correct wiring, the controller can not detect the motors position, is possible to change the detection method of the limit switches connected to IN1 / IN2 inputs. If the state of the motor position is detected inversely, i.e. the motor is physically in the closed position and the visualization indicates that it is open, it means that the pairs of wires in the IN1 / IN2 inputs have been changed, so the option should be changed in the field "Inputs swap (IN1, IN2)" to "Enabled".

## 3

## ACCESS POINT AND WIFI NETWORK SETTINGS

- Once you turn on the controller for the first time, you can proceed to its further configuration. Being connected to the WiFi network emitted by the device, in the control panel of the wBox application select the device, then go to "Settings" (icon at the top-right corner of the screen).



- You can change the name of the device that is displayed in the wBox application. In addition, you can change the name and password of its generated WiFi network. Remember that changing the network name or password will disconnect the device immediately after you click the "Save" button, so re-connect to the device using the newly assigned network name and password.
- You can add the controller to your home WiFi network to control it through this home network or from anywhere in the World. To do this, in the "Connect" settings section, select a network name from the list and press "Connect". If is required, enter the WiFi network password. During the connection of the controller to your home network, the phone / tablet may be disconnected from the network. In this case, you will need to reconnect your phone / tablet to the controller network.
- Please remember that in order to control the device outside the local WiFi network, from anyplace in the World by using the wBox application, the option "Remote access enabled" in the controller settings must be set to "Yes".
- Once you've finished configuring the WiFi network, you can disconnect your phone/tablet from the controller network and connect your mobile device directly to your home WiFi network. The control from the wBox application will work the same way as when the phone / tablet is connected to the controller network. If the user leaves the local network, for example, leaving home or using the mobile data, the wBox application will signal this state as "Remote mode". In this case, the devices can be controlled, but for security reasons settings are not available.

4

## ACCESS MANAGEMENT

- Return to the controller settings. In the "Access management" section, you can also create accounts for the gate users. This provides additional protection for access to the controller. If you create users, the option of adding a controller to the wBox application and its control will be available only after entering the correct login and password.
- To add a new user, in the "Access management" section, press the "Add" button and then fill in the new window the "User name" and "Password" fields and press the "Save" button. If at least one user account is added, the controller will require logging each time the controller is added to the wBox application. Only after logging in the controller, it will be possible to control the motor.

## TECHNICAL SPECIFICATIONS

supply voltage	12-24V AC / DC
energy consumption	< 1 W
number of outputs	2
output type	open collector, pulse
maximum load	20mA
number of inputs	2
inputs type	logical
voltage range	12 - 24V AC / DC
galvanic isolation	yes
housing	plastic, covered with a polyurethane composition not containing halogens, self-extinguishing for thermal class B (130°C)
protection level	IP54

antenna output	yes
antenna connector type	RP-SMA
antenna	omnidirectional, 5dB gain - included in the kit
dimensions	50 x 92 x 28 mm (without antenna), 85 x 230 x 28 mm (with the antenna located vertically), antenna length 197 mm
transmission type	bi-directional, encrypted
radio frequency	2.4 GHz
communication standard	µWiFi, compatible with WiFi, 802.11g
mode	direct connection (as Access Point), Wi-Fi connection via a standard router, connection with access from any location in the world (requires only access to the Internet)
compatible devices and systems	Apple iPhone, Apple iPad, iPad Mini, Android, computers and mobile devices supporting HTML5

## ADDITIONAL INFORMATION

### SOFTWARE UPDATE

To update the software in the controller, connect it to your home WiFi network (see "Access Point and WiFi Network Settings" section) which is connected to the Internet. Go to "Settings" (icon at the top-right corner of the screen) and click the "Get new firmware" button in the final section on settings. Wait about 1 minute, do not close the interface and don't perform other actions. The device will download the latest software. The software version number, hardware version and device identifier can be read at the bottom of the settings screen.

for å få mer informasjon  
besøk vår nettside

[www.bleboxnorge.no](http://www.bleboxnorge.no)

eller send en e-post til  
post@bleboxnorge.no

made in europe



proudly made by  
**blebox**

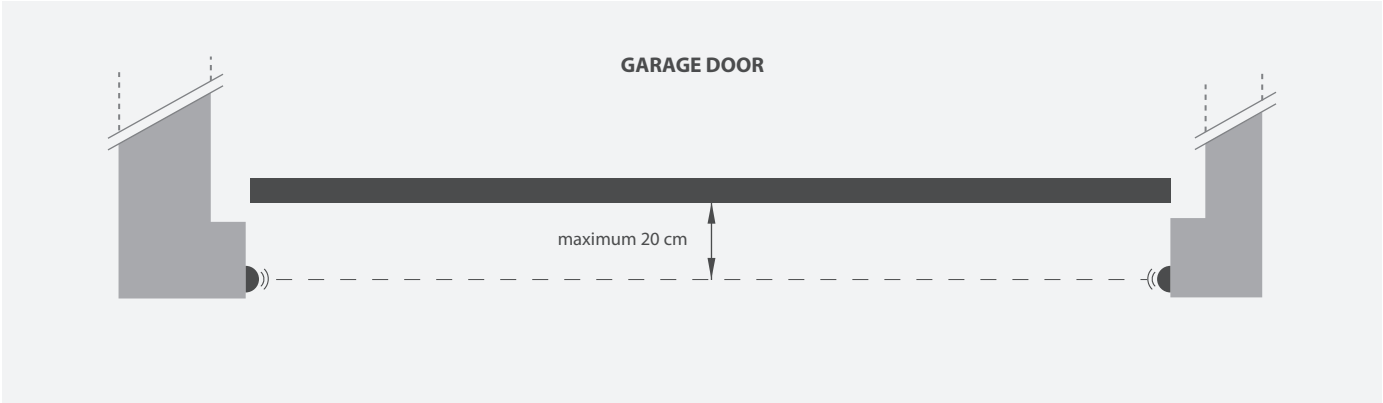
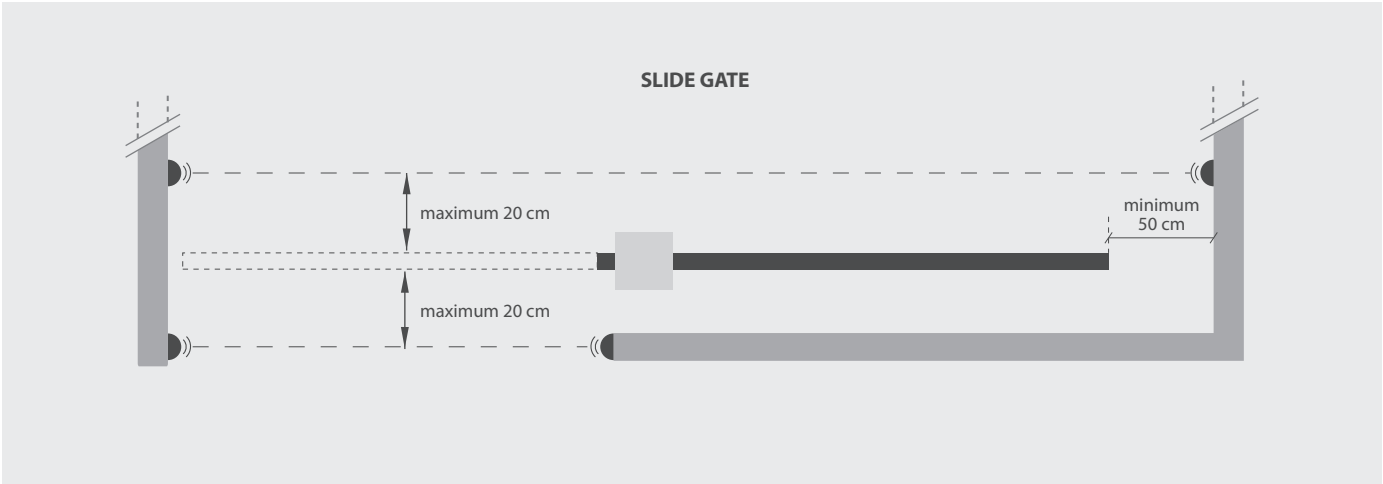
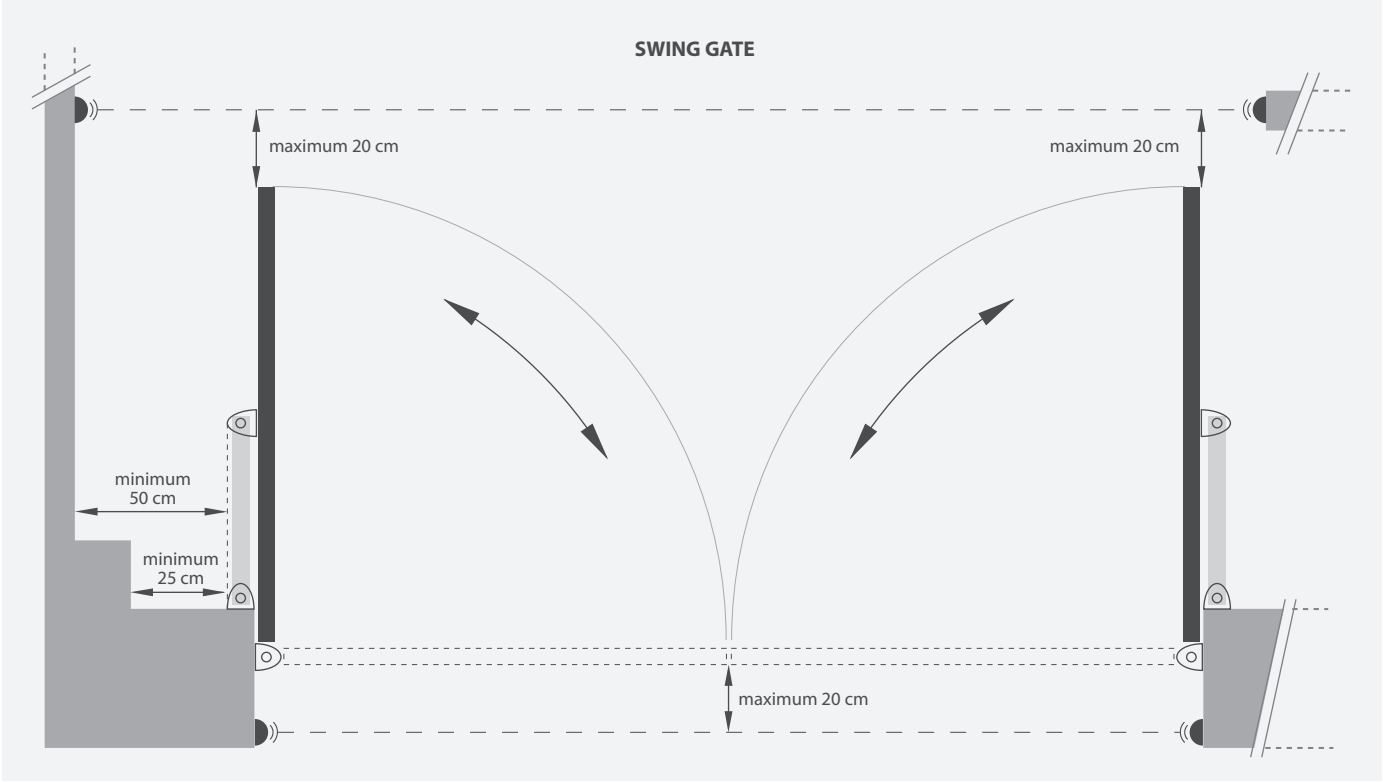

**CONNECTION EXAMPLE OF REEL SWITCH FOR SECTIONAL DOORS**

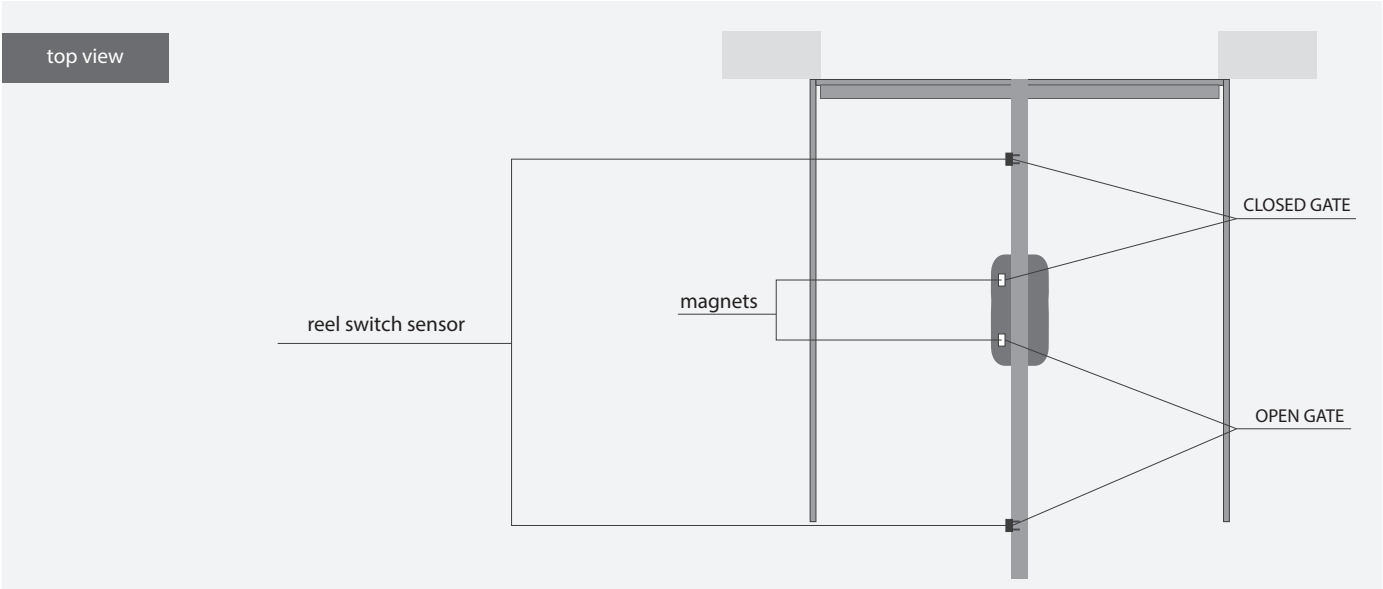
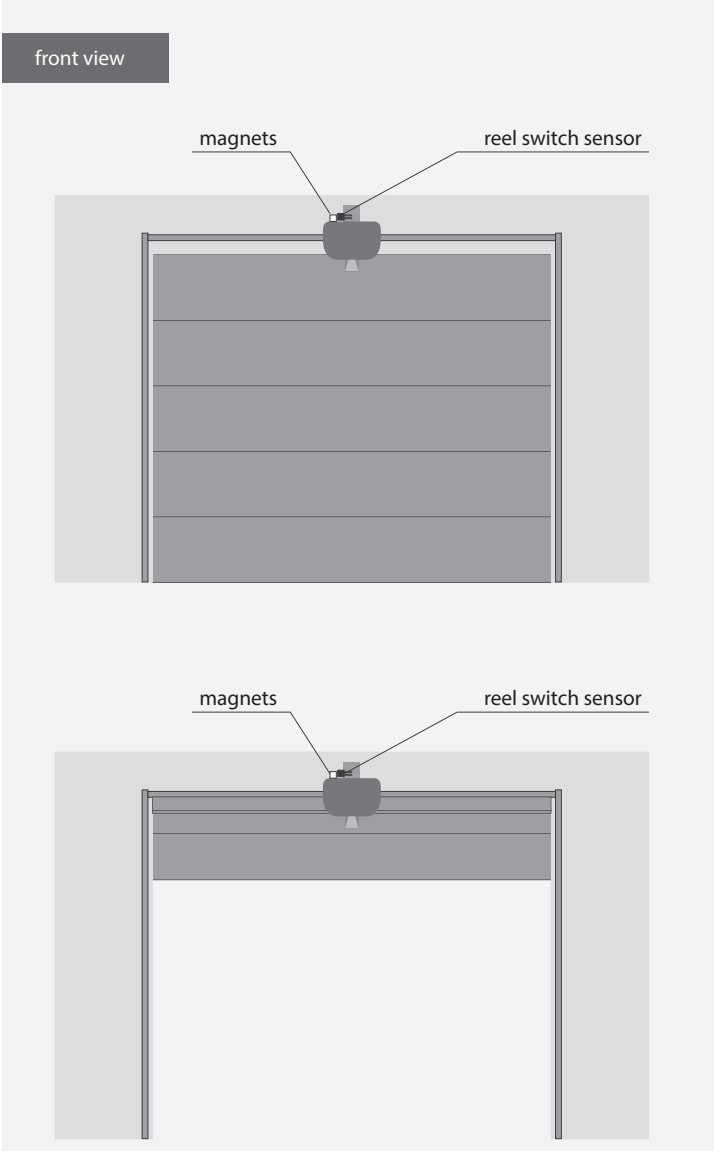
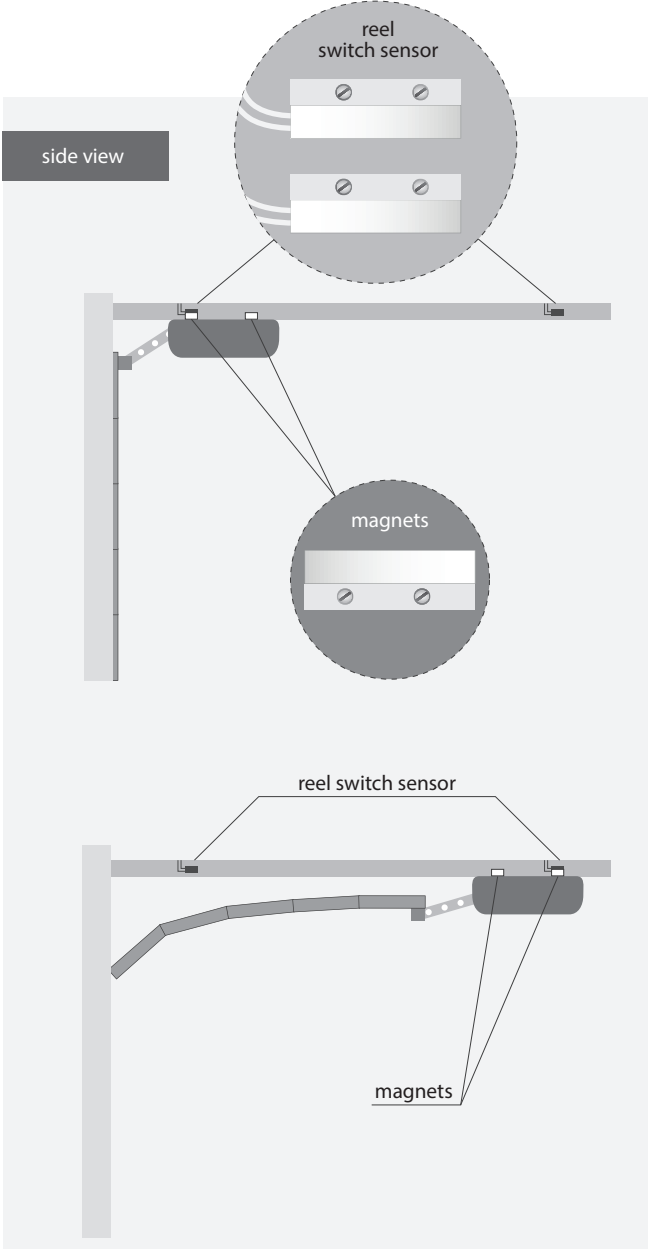

CONECTION EXAMPLE OF REEL SWITCH FOR SLIDING GATE

